

PRODUCTS | SERVICES

EASIRAIL HANDRAILS

easiaccess[®]

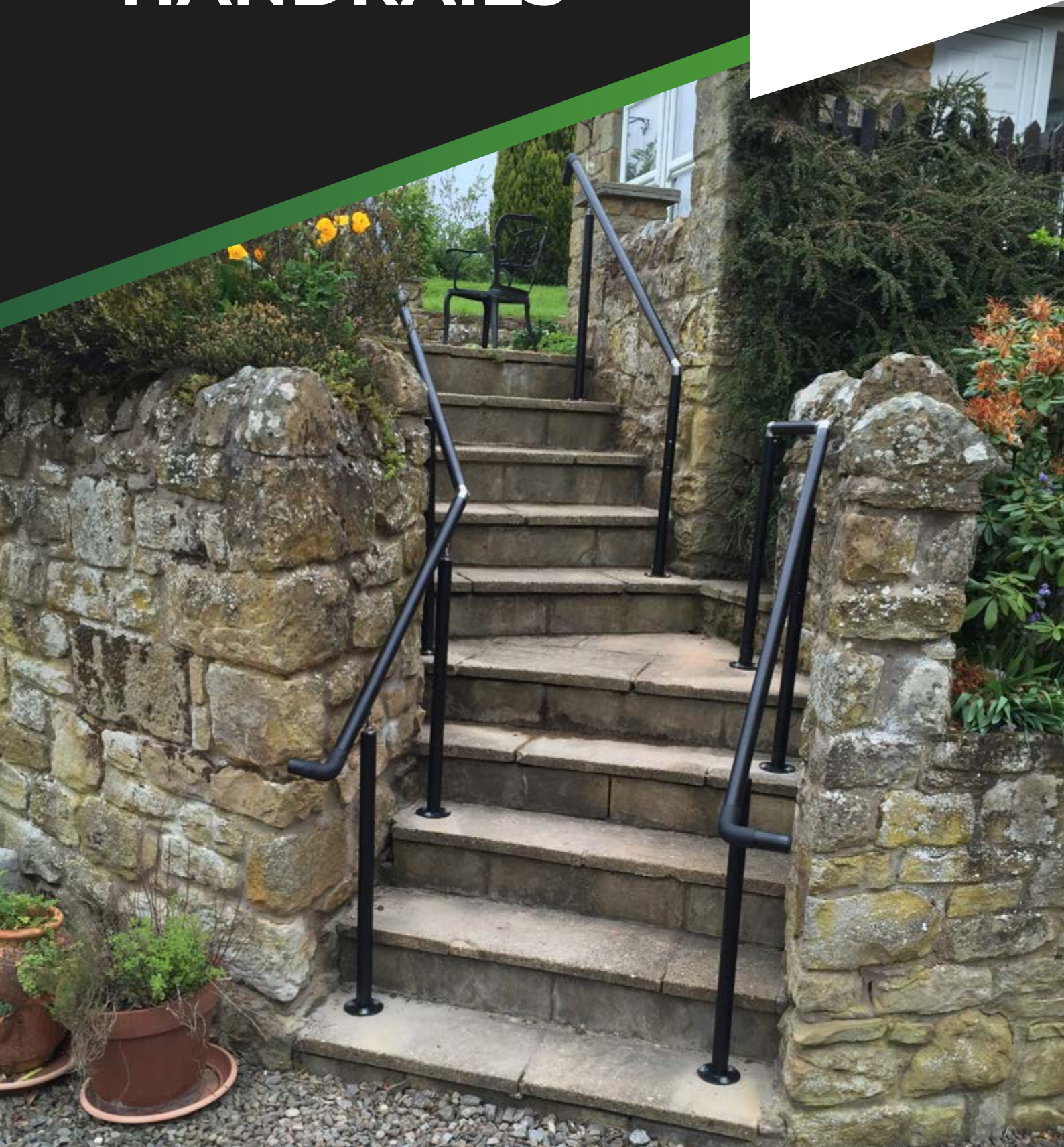

Whether positioned alongside existing steps or running down a walkway, Easirail avoids the traditional “industrial look” that other handrail systems provide, with oversized joints and a bare unpainted finish.

Using high quality materials and finishes, Easirail is designed to be fast to install, offering flexibility for a wide array of configurations.

All components are fully galvanised and ready coated in a warm touch finish for effective corrosion resistance.

The handrail is either selected from our pre-cut lengths or simply cut to size and attached using ultra strong rivets, providing a quick and secure method of installation.

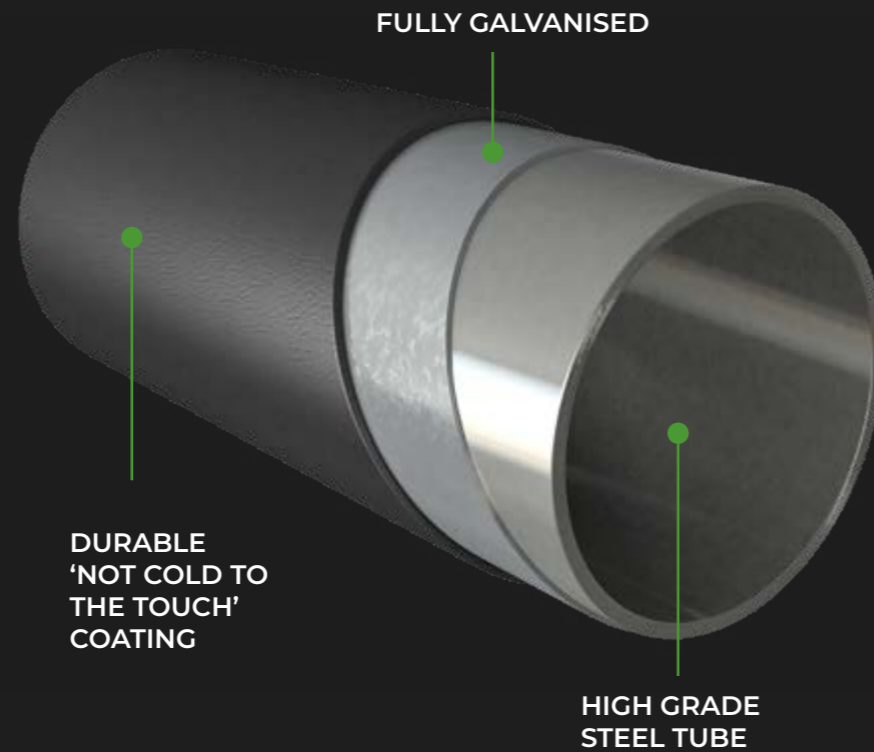

FEATURES AND BENEFITS



WARM TOUCH COATING



ADJUSTABLE BRACKETS FOR FLEXIBILITY



EASILY INCORPORATES A 600MM MIDRAIL



SURFACE MOUNTED OR FIXED USING CONCRETE



SATISFIES BUILDING REGULATIONS AND GUIDANCE



AVAILABLE IN A VARIETY OF LENGTHS



STRONG CONSTRUCTION AND TESTED COMPONENTS



PROVIDES A CONTINUOUS 42MM DIAMETER HANDRAIL



QUICK AND EASY TO INSTALL WITH NO PAINTING REQUIRED



FULLY GALVANISED PROVIDING AN EFFECTIVE CORROSION RESISTANT FINISH



CONTENTS

- EASIACCESS SERVICE.....4
- PRODUCT SPECIFICATION7
- STEP KITS8
- WALL BRACKETS9
- POSTS AND CONNECTORS10
- ACCESSORIES.....13
- RIVETS.....14
- BEST PRACTICE INSTALLATION GUIDE16

EASIIACCESS SERVICE



SUPPLY ONLY OR DESIGN AND INSTALLATION

Available as supply only or on a supply and install basis, Easiaccess guarantee excellent service provision from start to completion of your project.

Our sales and service team are able to assist you from initial enquiry and supply, through to design, installation and after sales support.

Our knowledgeable team can advise the correct specification of equipment for the type of configuration you need.

Should you require an installation service, Easiaccess have a wealth of experience in access solutions, from individual homes to large scale refurbishments.

Easirail installation teams are efficient and thorough, ensuring every installation is conducted with minimum disruption and the area is left clean and tidy. All Easirail configurations are ready for use immediately after installation.

We can also provide training on the full Easirail product range and its installation, giving you all the knowledge you need to both specify and install in any environment.

DISTRIBUTION

Easiaccess have extensive warehousing capabilities, allowing for a comprehensive stock inventory of Easirail to be held at any one time.

This enables us to cater for all of your Easirail requirements, with the aim of dispatching handrail and fittings to you within 48 hours.

For more information, contact our sales team on 0191 460 2777 or email at info@easiaccess.co.uk.

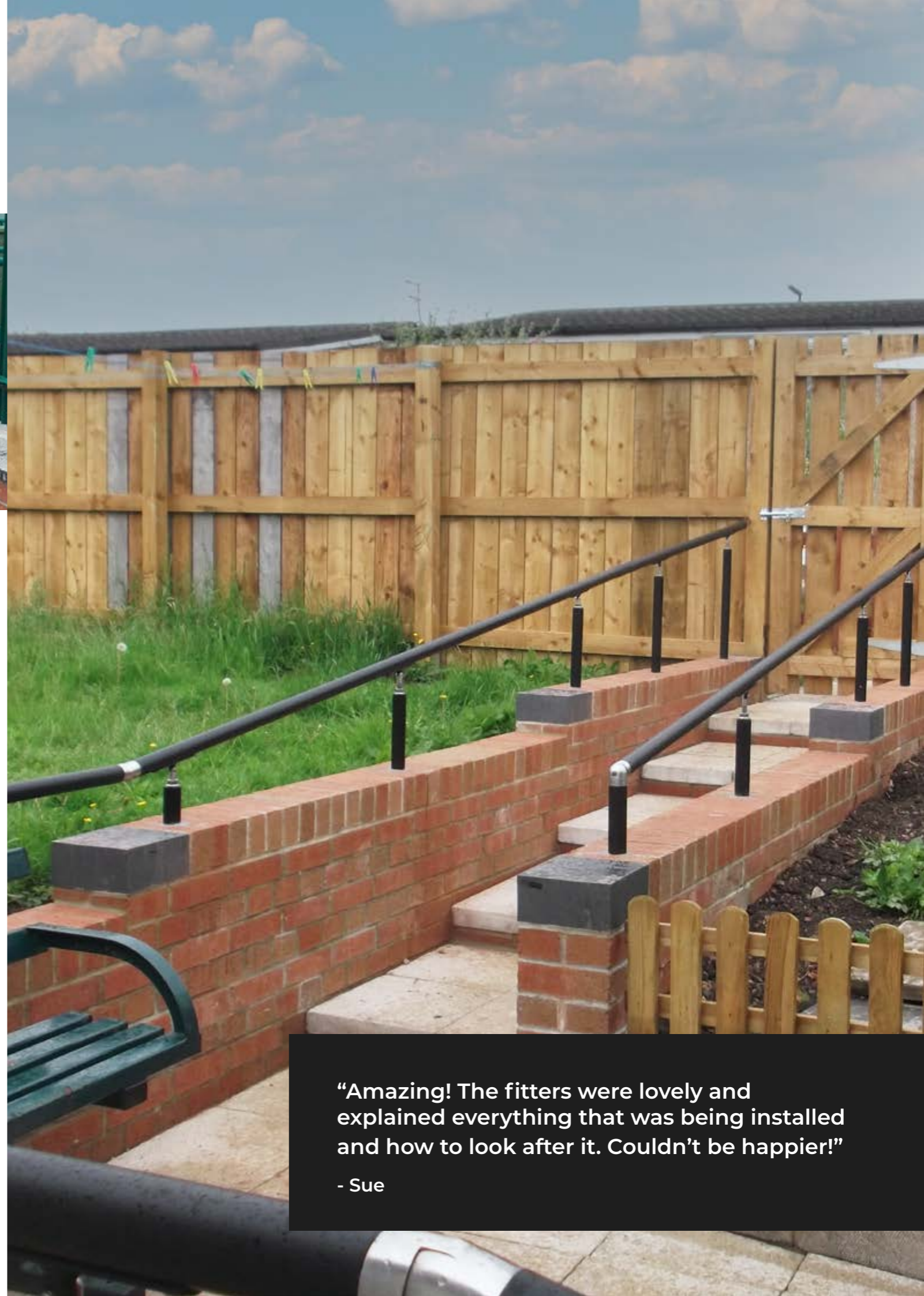

“Amazing! The fitters were lovely and explained everything that was being installed and how to look after it. Couldn’t be happier!”

- Sue

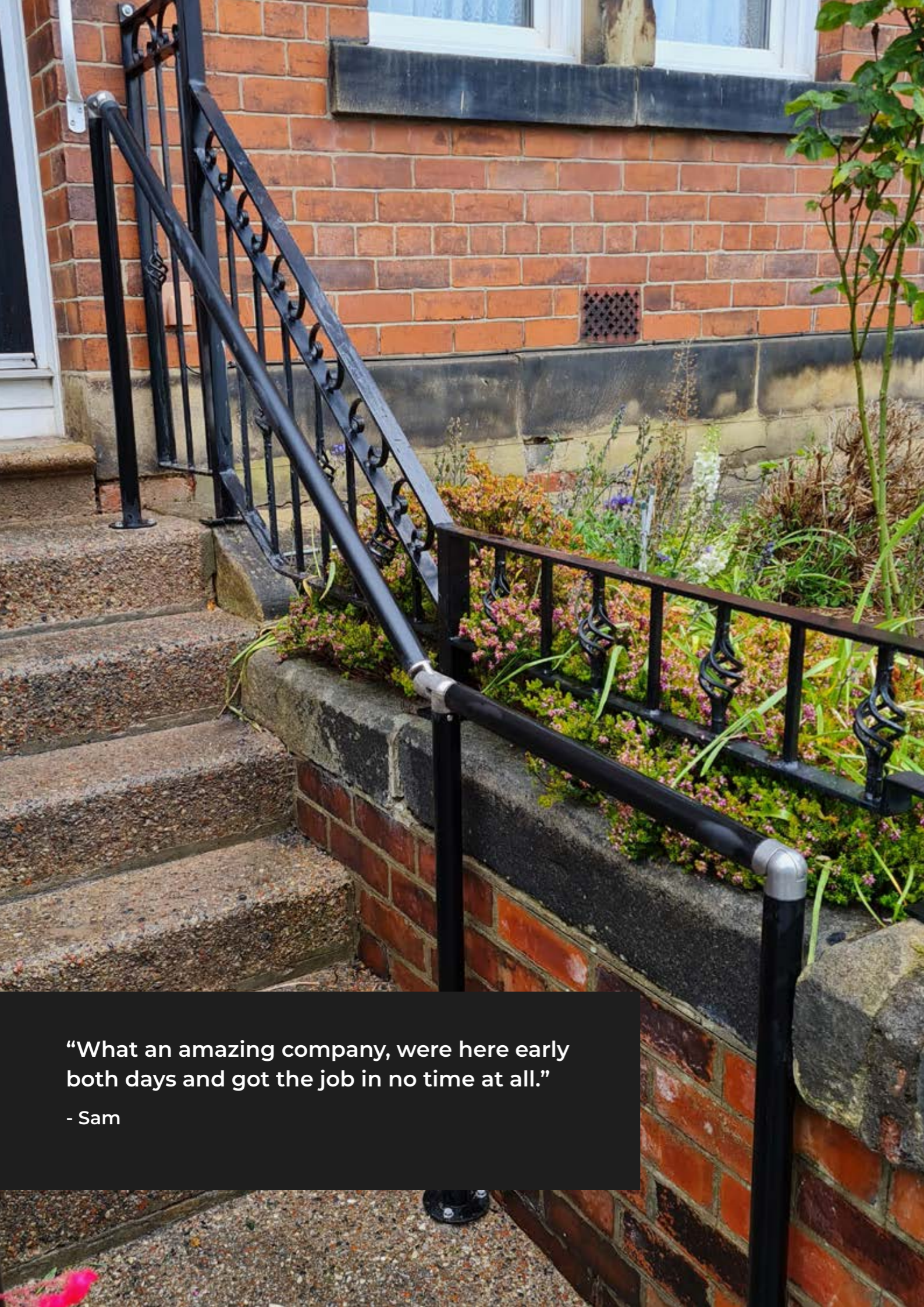

“What an amazing company, were here early both days and got the job in no time at all.”

- Sam

EASIRAIL

HANDRAIL SYSTEMS

PRODUCT SPECIFICATION

EASIRAIL HANDRAIL

Our 42mm handrail tube is attached directly to the posts and brackets using 4.8mm domed rivets providing a quick, strong and tamper resistant method of attachment. Additional rivets can be used to provide enhanced security, if required. All tubes are fully galvanised and powder coated providing a long lasting fine textured finish.



CODE	DESCRIPTION	Standard Colours
H1	100mm Handrail - also provides a simple termination with a CCON and HEC	Black
H2	200mm Handrail	Black
H3	300mm Handrail	Black
H4	400mm Handrail	Black
H5	500mm Handrail	Black
H6	600mm Handrail	Black
H7	700mm Handrail	Black
H8	800mm Handrail	Black
H9	900mm Handrail	Black
H10	1000mm Handrail	Black
H11	1100mm Handrail	Black
H12	1200mm Handrail	Black
H15	1500mm Handrail	Black
H20	2000mm Handrail	Black
H30	3000mm Handrail	Black

Black RAL9005

EASIRAIL CAPS

The handrail tube is used in conjunction with the range of connectors and end caps, which either have a friction fit or are glued into position, providing an effective way to terminate a handrail.



HEC(B)
HANDRAIL END CAP

Inserts into the open end of the rail

BOX QTY: 40



VHEC(B)
VINYL END CAP

Covers the open end of a rail

BOX QTY: 40

STEP KITS

An off the shelf solution offering everything you need to provide handrail assistance at a stepped access point.

EASIRAIL WALL TO FLOOR STEP KITS

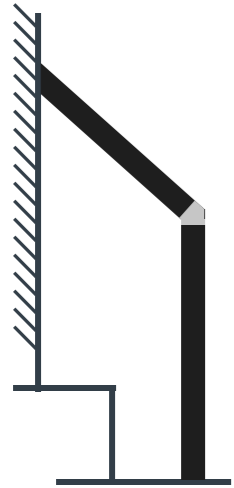

ER-WF1 (B)

WALL TO FLOOR 1 STEP KIT
Wall to floor handrail to fit single step projecting 270mm - 300mm

Kit includes ER-VP9T(B), UCON, H5(B), SWCON, HEC, and glue

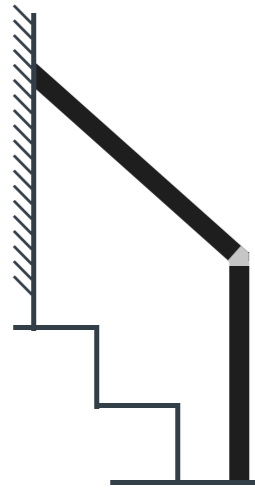

ER-WF2 (B)

WALL TO FLOOR 2 STEP KIT
Wall to floor handrail to fit two steps projecting 540mm-600mm

Kit includes ER-VP9T(B), UCON, H8(B), SWCON, HEC, and glue

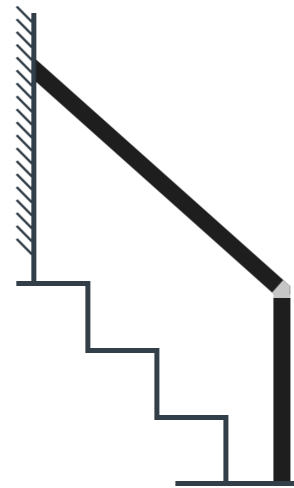

ER-WF3 (B)

WALL TO FLOOR 3 STEP KIT
Wall to floor handrail to fit three steps projecting 820mm-900mm

Kit includes ER-VP9T(B), UCON, H11(B), SWCON, and glue

EASIRAIL FLOOR TO FLOOR STEP KITS

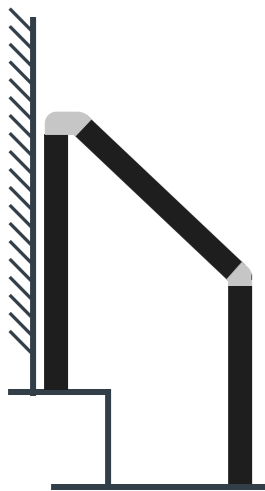

ER-FF1 (B)

FLOOR TO FLOOR 1 STEP KIT
Floor to floor handrail to fit single step projecting 270mm — 300mm

Kit includes ER-VP9T(B) x2, UCON, DCON, H5(B), and glue

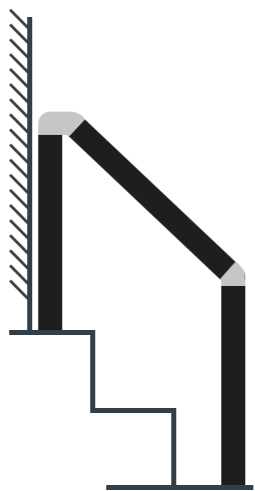

ER-FF2 (B)

FLOOR TO FLOOR 2 STEP KIT
Floor to floor handrail to fit two steps projecting 540mm — 600mm

Kit includes ER-VP9T(B) x2, UCON, DCON, H8(B) and glue

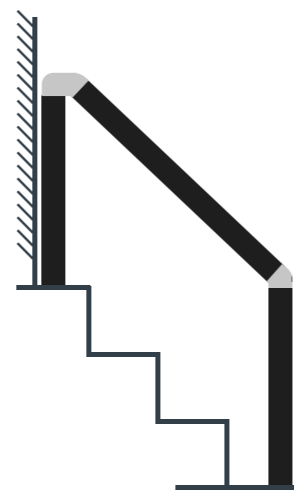

ER-FF3 (B)

FLOOR TO FLOOR 3 STEP KIT
Floor to floor handrail to fit three steps projecting 820mm — 900mm

Kit includes ER-VP9T(B) x2, UCON, DCON, H11(B) and glue

EASIRAIL WALL BRACKETS

The range of brackets provide the ability to attach a handrail to the wall, vertically or horizontally whilst the midrail bracket attaches to the adjustable posts creating a 600mm high inset midrail.

*Any RAL can be requested at additional cost. Please note all plates supporting the handrail are now stainless steel - see page 11.



ER-MINI-SPBK(B) WALL BRACKET

Attaches rail to a wall in fixed positions

Requires x2 wall fixings (not included)

Standard Colour: **BLACK (RAL 9005)**



HANDRAIL BRACKET

Attaches rail to a wall allowing horizontal angle adjustment

Requires x3 wall fixings (not included)

Standard Colour: **BLACK (RAL 9005)**



ER-SPBK(B) WALL BRACKET

Attaches rail to a wall which is riveted in to position

Requires x4 wall fixings (not included)

Standard Colour: **BLACK (RAL 9005)**



ER-SBKTL(B) HANDRAIL BRACKET LEFT

Attaches rail to a wall offset, for ease of use. Allows vertical adjustment

Requires x3 wall fixings (not included)

Standard Colour: **BLACK (RAL 9005)**



ER-MBKT(B) MIDRAIL BRACKET

Attaches to a vertical post providing a 600mm high inset midrail with horizontal adjustment

Standard Colour: **BLACK (RAL 9005)**



ER-SBKTR(B) HANDRAIL BRACKET RIGHT

Attaches rail to a wall offset, for ease of use. Allows vertical adjustment

Requires x3 wall fixings (not included)

Standard Colour: **BLACK (RAL 9005)**



ER-SBK(B) STEP BRACKET

Attaches rail to a wall allowing vertical angle adjustment

Requires x2 wall fixings (not included)

Standard Colour: **BLACK (RAL 9005)**

POSTS

EASIRAIL POSTS

Our adjustable posts are either surface mounted by securing directly to the ground or permanently fixed into concrete. The high-grade stainless-steel thread provides up to 30mm vertical adjustment, making an installation even easier when the ground is not running quite level.

OPEN TOP TO RECEIVE A CONNECTOR



ER-VP9T(B)
VERTICAL TERMINATION POST

900mm handrail post screwed/bolted directly to the floor

PIVOTING TOP PLATE



EASY TO USE LOCK SYSTEM

HEIGHT ADJUSTABLE

ER-VP9(B)/VP14(B)/VP18(B)
VERTICAL POST

900, 1400 or 1800mm post lengths to support a handrail

POSTS

All our vertical posts, except for the termination post ER-VP9T(B), and bracketry incorporate a marine grade stainless steel top plate bringing the following benefits:

- Resistant to corrosion and harsh environments even when they have been drilled or scratched.
- Due to the construction of the stainless steel top plate, it ensures the handrails are exceptionally strong, durable, and long lasting.
- All vertical posts that utilise the top plates are embossed with our company logo – so you know you are getting a genuine product. The connectors are embossed with the product code for easy identification.
- Widened profile to better support the handrails and “cupped” to provide increased rigidity.
- Multiple rivet hole positions and a short plate allowing for an easy, flexible installation.
- Stainless steel finish to match our connector range, utilises screw thread giving a “premium” look.
- A wide range of horizontal adjustment is achieved by incorporating a central pivot point, allen bolt and nut to secure the rail in position.

EFFECTIVE CORROSION RESISTANCE



MULTIPLE RIVET HOLES FOR EASE OF ATTACHMENT

ADJUSTABLE FOR FLEXIBILITY

EASIRAIL POST OPTIONS

CODE	DESCRIPTION	STANDARD COLOUR
ER-VP9	900mm Vertical Post – floor fixed post with a stainless steel height adjustable pivoting bracket (requires x3 floor fixings, not included).	Black RAL 9005
ER-VP14	1400mm Vertical Post – can be set into concrete or attached to a side wall and complete with stainless steel height adjustable pivoting bracket.	Black RAL 9005
ER-VP18	1800mm Vertical Post – can be set into concrete or attached to a side wall and complete with stainless steel height adjustable pivoting bracket.	Black RAL 9005
ER-VP9T	900mm Vertical Termination Post – provides termination of a 900mm handrail straight to the ground; screwed or bolted directly to the floor.	Black RAL 9005
H15 (Used as post)	H15 Handrail 1500mm – can be used as vertical termination post; to be core drilled into ground with 900mm high projection from ground. Other lengths can also be used for this purpose.	Black RAL 9005

Our posts can easily incorporate a midrail (using our ER-MBKT or IMCON) and satisfy all access regulations. The termination post, which is secured to the ground, provide an alternate means of finishing a handrail without a return loop or overhang.

If you have any queries about our Easirail post options or any other Easiaccess product then please do contact us and a member of our team will aim to help you as best as we can.

CONNECTORS

EASIRAIL STAINLESS STEEL CONNECTORS

Stainless steel connectors are precision manufactured from an external grade material ensuring longevity and are simply glued into position, or riveted providing an extremely strong fix. More connectors are in development so stay in touch for updates.



UCON
ADJUSTABLE CONNECTOR
Connecting rails between 90-180°

BOX QTY: 5



MCON
MULTI ANGLE CONNECTOR
Connecting a post and rails at a horizontal and vertical angle

BOX QTY: 5



CTCON
CORNER TEE CONNECTOR
Connecting rails at 90° and a post

BOX QTY: 5



DCON
TERMINATION CONNECTOR
Connecting a post and rail at variable angles

BOX QTY: 5



SWCON
STEP WALL CONNECTOR
Connecting rails at an angle to a wall

BOX QTY: 5



SSCON
STRAIGHT CONNECTOR
Connecting two straight rails

BOX QTY: 5



IMCON
INLINE CONNECTOR
Providing an in-line midrail or post extension

BOX QTY: 5

EASIRAIL STANDARD CONNECTORS

The standard connectors provide a friction fit and are manufactured from a UV resistant, hard wearing thermoplastic outer cover and nylon inner collar.



ACON(B)
ANGLE CONNECTOR

Connecting rails that meet at an angle (~1:12)

BOX QTY: 10



CCON(B)
CORNER CONNECTOR

Connecting rails that meet at 90°

BOX QTY: 10



SCON(B)
STRAIGHT CONNECTOR

Connecting straight rails

BOX QTY: 10



WCON(B)
WALL CONNECTOR

Connecting rails to the wall

BOX QTY: 10

ACCESSORIES

EASIRAIL ACCESSORIES

Our handrail system includes a multitude of accessories to assist with any installation. Please see a list of some of them below.

CODE	DESCRIPTION
ER-SGHV	Easiaccess quick set glue (50ml)
M12-20	Battery rivet tool with 12v 2.0Ah battery and charger
GREASE	Grease 400ml - for use when installing rails with rivets
SPRAY	RAL matched spray 9005
RVT	Stainless steel domed head ultra-strong rivets
FFXN	Floor fixing - Concrete Anchor Bolt HUS-V 8x95 HILTI
WFXN	Wall Fixing - Concrete screw fixing HUS 6x45 HILTI



SPRAY
RAL MATCHED SPRAY
Available in RAL 9005



ER-SGHV
QUICKSET GLUE
Easiaccess quick set glue (50ml)



RVT
ULTRA STRONG RIVETS
Stainless steel domed head



M12 BPRT-201X
BATTERY RIVET TOOL
12v 2.0Ah battery and charger



FFXN
FLOOR FIXING
Concrete Anchor Bolt HUS-V 8x95 HILTI



GREASE
400ML GREASE
For when installing rails with rivets



WFXN
WALL FIXING
Concrete screw fixing HUS 6x45 HILTI

RIVETS

DOMED HEAD STRUCTURAL RIVET

Our rivets are multi-grip structural break-stem fasteners, providing a fully sealed joint and visible lock for quick and easy inspection.

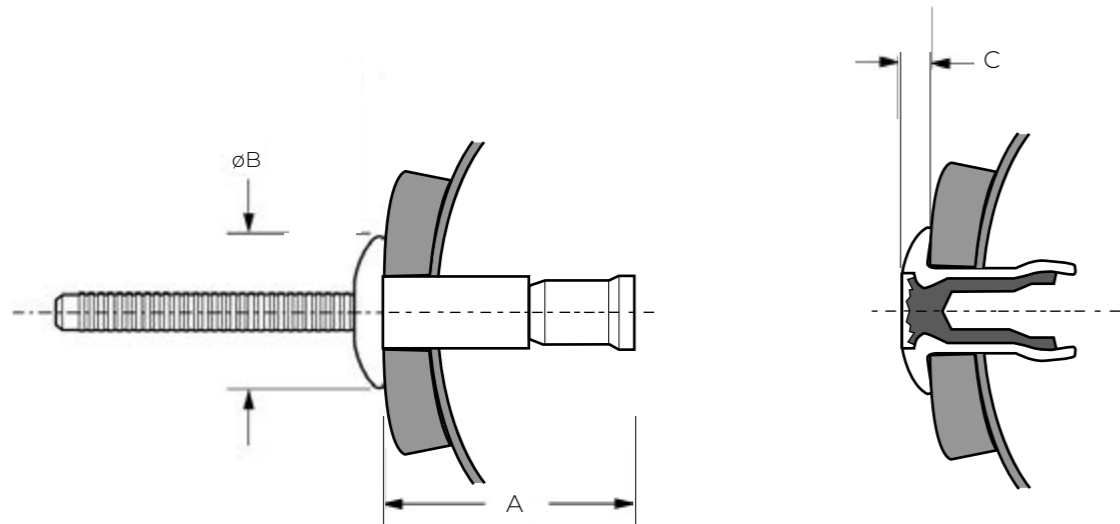

Body: Stainless steel

Stem: Stainless steel

Rivet Size	Body Diameter (mm)		Stem Length (mm)		A (mm)	B (mm)	C (mm)	Shear Force (kN)	Tensile Force (kN)
	min.	max.	min.	max.					
4.8	1.58	6.85	4.9	5.1	18.2	10.2	2.5	6	4.5

Measurements in millimetres unless otherwise stated.

Key Features

- Excellent hole fill via radially expanded body provides very strong, vibration resistant joints and compensates for irregular, oversized, slotted or misaligned holes
- Good sheet take-up performance for large gap closing capability
- Stem mechanically locked into body avoids damage, electrical problems or rattling caused by loose stems
- Multi-grip capability
- High shear and tensile strength
- Visible lock for quick and easy inspection
- Stainless steel for effective corrosion resistance

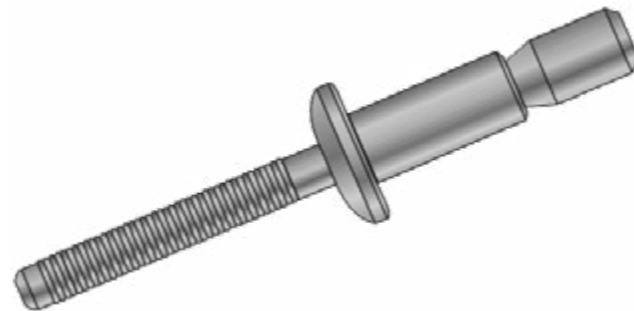

RIVETS

MILWAUKEE M12

An ergonomic cordless tool that offers reliable performance from a trusted brand.

The Milwaukee M12 is an ergonomic pop rivet tool with high performance motor for maximum productivity. RedLink overload protection delivers reliable performance and durability.

It can deliver up to 325 x 4.8mm stainless steel rivets on a single charge. Features tool-free access to easily clean the jaws, on-board nose-piece storage and removal tool for user convenience.

1 x 2.0Ah battery pack is included. Supplied in a heavy duty case and a 4.8mm nose-tip to suit our specific structural rivets.

Key Features

- Suitable for 2.4, 3.2, 4.0 & 4.8mm rivets
- LED work light
- Trigger switch
- 40 minutes charge time
- Lightweight construction
- Integrated belt hook
- 9 kN pulling force
- Mendrel collection attachment



What's included?

- 1 x Milwaukee M12 rivet gun
- 1 x 2.0Ah battery pack
- 1 x Charger
- 4 x Nose tips in various sizes
- 1 x 4.8mm nose-tip for use with our rivets
- 1 x Heavy duty case
- 1 x Instruction manual

BEST PRACTICE INSTALLATION GUIDE

REGULATIONS

Domestic Regulations

Over steps, a handrail should be between 850 - 1000mm from the pitch line of the flight and extending a minimum of 300mm beyond the top and bottom step. Over ramps, the vertical height to the top of the handrail from the surface of the ramp is between 900mm and 1000mm.

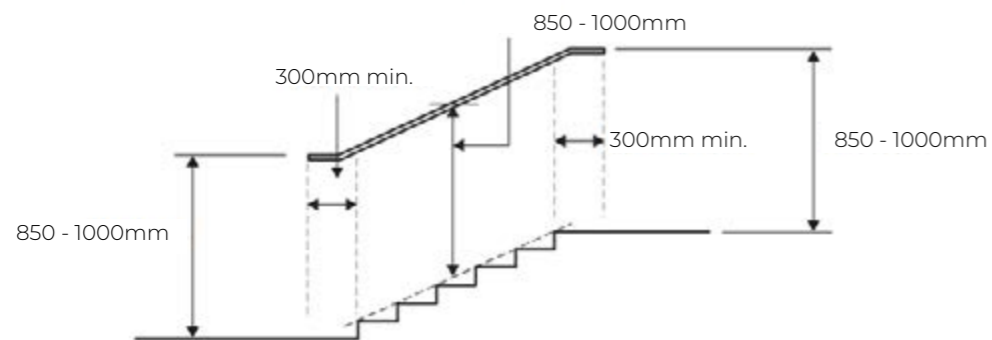

Public Access Regulations

The vertical height to the top of the handrail, above the pitch line of the steps or ramp surface, must be between 900mm and 1000mm.

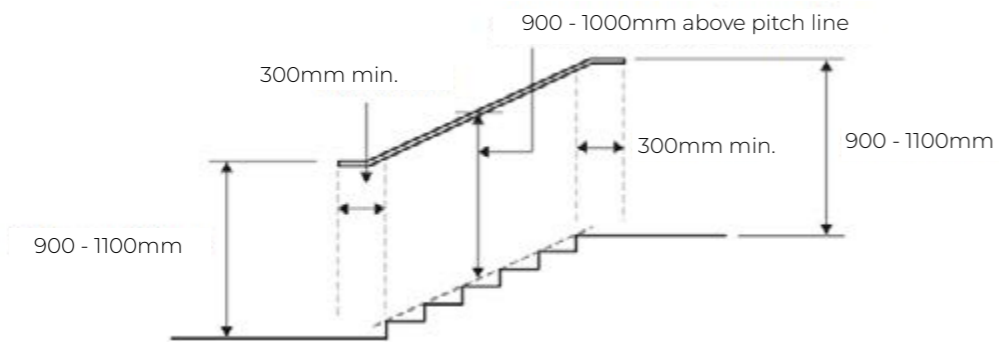

INSTALLATION

Recommendations

With any installation that requires fixing to a wall or floor, an evaluation must be made on site as to the structural integrity of the surface that will provide the strength, be it a wall, floor, step or other.

Here are guidelines as to how Easirail should be installed in a number of common situations. As a general rule and in all circumstances, we suggest setting posts no more than 1200mm apart. This distance can be reduced in high traffic areas or to accommodate specific client and/or environmental considerations.

BEST PRACTICE INSTALLATION GUIDE

INSTALLATION

Concrete/Core Drilling

Core drill using 50-60mm bit to the depth of at least 250mm. Set post in concrete/postcrete. *

Concrete - Floor Fixing

Mark and drill holes and use suitable exterior grade fixings through base plates of posts. Avoid drilling near edges as this may cause cracking of concrete. We recommend using galvanised threaded concrete bolts or anchor bolts.

Tarmac - Core Drilling

Core drill using 50-60mm bit to the depth of at least 300mm. Set post in concrete/postcrete. Proceed with caution when core drilling into tarmac as the quality of the tarmac can vary significantly. If unsure, proceed with the following installation method. *

Tarmac - Digging/Sawing

Cut a square with a concrete cutting saw and dig down to a minimum of 300mm, fill the hole with concrete/postcrete to secure. Easiaccess use a black dye to match with tarmac.

Flags - Core Drilling

Core drill using 50-60mm bit to the depth of at least 300mm. Set post in concrete/postcrete.*

Flags - Floor Fixing

For this option, the flag size must be a minimum of 600 x 600 x 50mm. Ensure flag is in a good condition and is firmly secured. In this situation, Easiaccess would use a galvanised threaded concrete bolt or anchor bolt, taking care when drilling and tightening, to avoid breaking the flag.

Block Paving

To set into ground, remove at least two blocks and dig down to a minimum of 300mm to achieve a good fixing, concrete/postcrete in place. Dye concrete to match block paving.

Bricks - Core Drilling

Core drill using 50-50mm bit. Drill through to a minimum depth to catch second course and set post in concrete/postcrete. *

Soft Ground

Dig down to a minimum of 300mm, tap post into clay/ground and fill hole with concrete/postcrete. Ensure concrete/postcrete is mixed well and to the correct ratios.

Wall Fixing

Ensure wall is flat and in sound condition and use suitable exterior fixings. The plate for the wall bracket will accept up to an 8m fixing and we recommend a minimum of 60mm long fixing to secure.

Choosing Fixings

There is not a single solution for fixings, as what might work on one surface may not be suitable for another. Always use a fixing that is rated for external use and is fit for purpose. Seek advice if unsure and refer to the product specification/guidance for the fixing under consideration.

Easiaccess uses the following chemical anchor/resin to secure the posts in combination with concrete/postcrete; FISCHER FIS VT VINYLESTER CHEMICAL MORTAR RESIN

For all our external screws/bolts we use HILTI fixings.

* N.B. Optional when core-drilling

Leave around 40-50mm space at the top and then fill remainder of the hole with an exterior grade fast set resin, leaving an ultra-strong and neat finish.



BEST PRACTICE INSTALLATION GUIDE

ADDITIONAL INFORMATION

Recommendations

Easiaccess supply handrail in several pre-cut lengths to reduce the need for cutting. If you do need to cut a handrail it must be sealed using a zinc rich spray and coated with a RAL matched paint. Easiaccess stock zinc rich sprays and matching paints in both green and black. Alternatively, if a cut rail is terminating with a stub end (for example butting up to a house wall) use a vinyl end cap (VHEC) to terminate the rail and a bead of silicone or glue to keep out any moisture. This removes the requirement for painting / drying, thereby reducing installation times.

The same care needs to be taken when drilling the handrail, as with any galvanised product, once the coating is broken, it must be sealed to prevent corrosion. After drilling the rail all metal filings must be removed. If the fillings are left exposed (without removing) they will rust and stain any surface they are in contact with.

Once any filings have been cleared away, dip the rivet in some grease before inserting into the 5mm hole. Be generous with the grease and simply wipe off when the installation is complete, as this forms a barrier between the steel and air.

From time-to-time rails will get damaged, either prior to installation or once installed. Surface knocks and scratches can easily be covered with the RAL matched paints. We would recommend carrying a small stock of these for such instances.

Riveting

When designing the Easirail handrail system we wanted to create a system that was very robust and could ensure a long-life span – hence our reason for utilising rivets as they maintain a high shear and tensile strength. It also allows a visible lock for a quick and easy inspection while remaining tamper proof.

Together with a cordless rivet gun which provides a quick and effortless method of attachment, you can be assured of many years trouble free use.

Gluing Stainless Steel Connectors

- Place a good coating of glue around the inside of the tube and quickly twist/screw in the connector to get a good coverage before it is finally aligned.
- Once the posts have set, consider marking and cutting all rails to size in advance to minimise disturbance on freshly glued joints.
- The glue can take up to 30 minutes to “go-off” however, this is subject to weather conditions and can easily vary (it takes around 24 hours to achieve maximum strength). During this time, avoid undue/excessive movement.
- If installing in inclement weather, consider placing a rivet through each connector to secure it.

Hints and Tips

An Easirail installation is only as good as the person installing it – always use the correct ground and exterior fixings.

Always use appropriate PPE (eye protection, gloves, etc.) when drilling, cutting, riveting and gluing.

The stainless steel thread and locking nut provide a level of vertical adjustability so you can “fine tune” an installation as required.

Check that you have drilled/riveted each bracket once an installation is complete and ensure all fixings are secure.

If you have any questions with regards to this guide or need any more information on the full product range, please contact one us.

“Arrived promptly, did an excellent job fitting handrails in the cold, no mess left. Would definitely recommend.”

- Mark



0800 321 7430
easiaccess.co.uk

Easiaccess is a division of Easibathie Limited.
© Easiaccess 2024, Federation Way,
Lancaster Road, Dunston, NE11 5JL.
Registered company number 03738301.